

KRAIBURG KEW Plus LongLine / KEW Plus LongLine TarsaCare

Prerequisites:



Concrete area:

- No holes
- No ridges
- Min. 3% slope

Mats:

Even temperature:
min. 5°C to max. 30°C
(store according to initial
temperature)

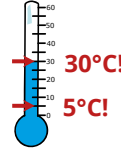

For animal well-being, a certain amount of bedding is necessary to absorb moisture (e.g. soft milled straw or mineral material)!

You will need:

Measuring:

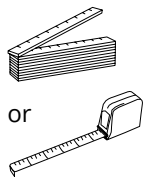

Marking:

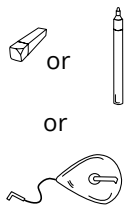

Cutting:

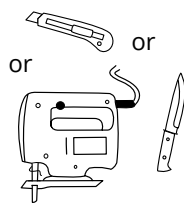

Drilling and installing:

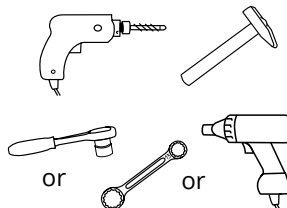

KRAIBURG fixings:



Framing plugs \varnothing 10 x 100 mm with
• Hexagon screws (AF 13) - A2
• Washers \varnothing 30 mm - A2

Framing plugs \varnothing 10 x 135 mm with
• Hexagon screws (AF 13) - A2
• Washers \varnothing 30 mm - A2

(Fixings are part of the delivery)

1 Placement line

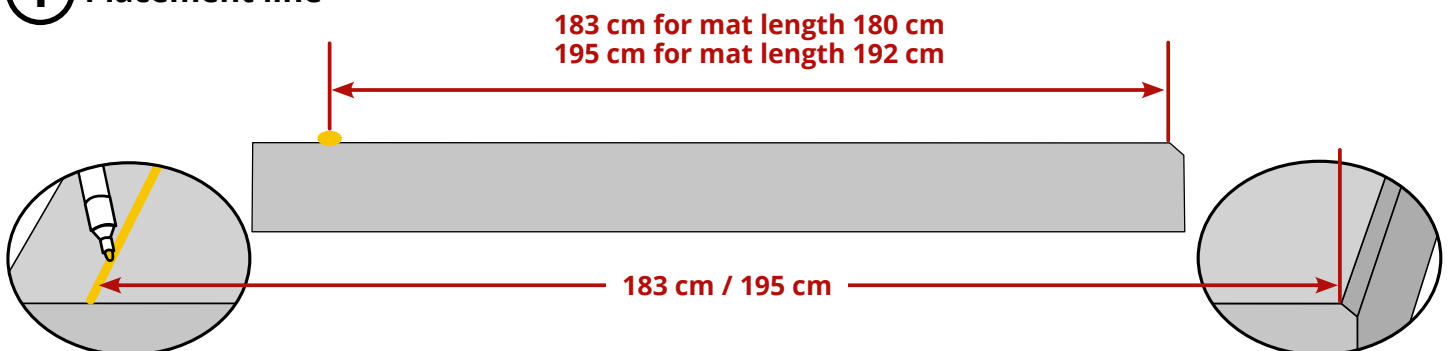

Draw a placement line at the front

Tip: Use a chalk line

Measure from the rear concrete edge

2 Install lower mats and foam

i Align lower mats to the placement line, allow space for the closure bars at the side edges (see step 5)

KRAIBURG logo on the head edge

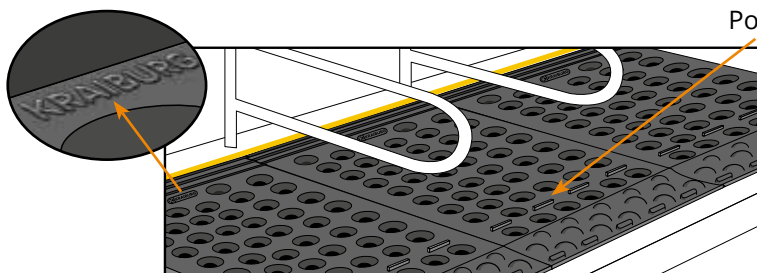

Install lower mats

Positioning bars

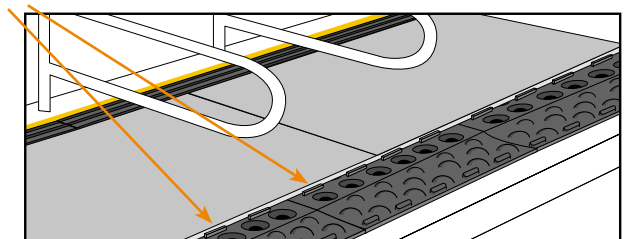

Insert foam crosswise within the positioning bars



3 Roll out and position rubber flooring

Head edge:
The connecting grooves of the upper mat and the lower mat engage perfectly

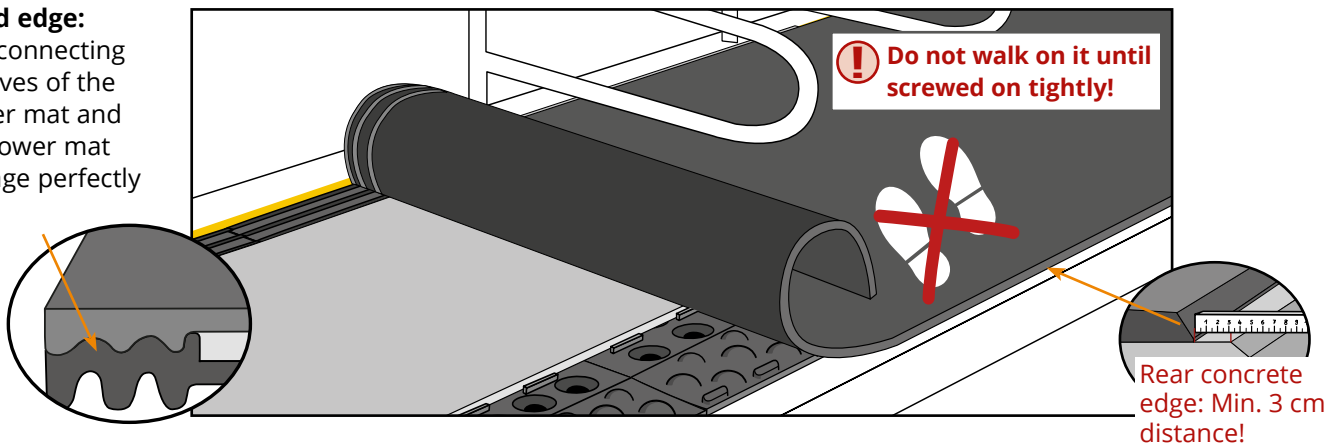

! Cutting out pockets for pillars or the like is not possible!

4 Fix

i Start from the center of the roll and fix on the right and on the left

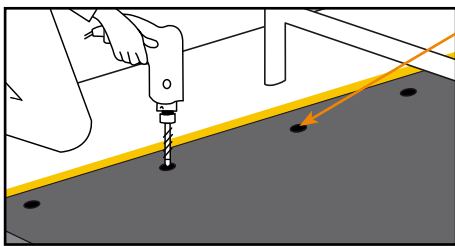

Fix at the front edge through the prefabricated fixing points

! Always make sure the front edge of the mat is located on the line.
Re-adjust, if necessary.

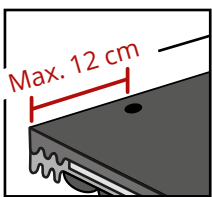
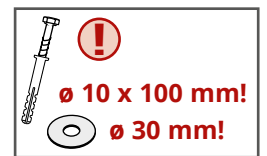

Distance between the mat edge and the outermost fixings: max. 12 cm!

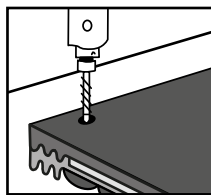

If the distance exceeds 12 cm:
Place an additional fixing point

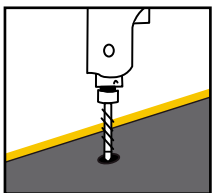

Drill

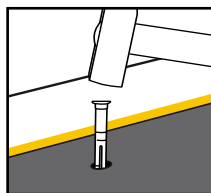

Knock the plastic plugs in flush

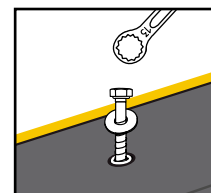

Tighten screws and washers

! Tighten screws until they are seated evenly and firmly and are slightly countersunk. **Do not overtighten!**

5 Fix side edge of the mat with a closure bar

A Position bars

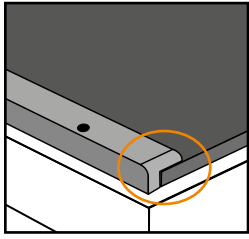

Left edge with bar

KEW Plus LL-L

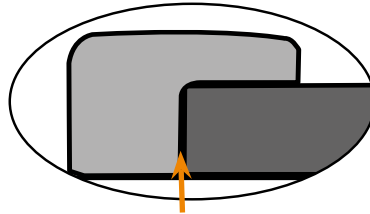

Contact

! DO NOT PRESS!

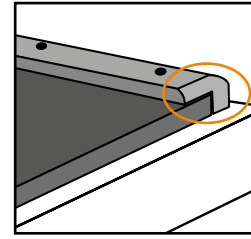

Right edge with bar

KEW Plus LL-R

- Rounded off end on the rear edge
- Flush with the rear edge of the mat

B Fix bars

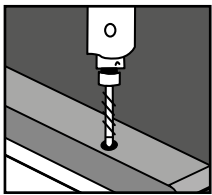

Drill

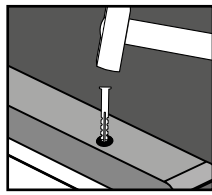

Knock the plastic plugs in flush

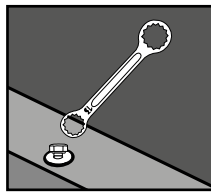

Tighten screws and washers until they are seated evenly and firmly.
Do not overtighten!



Tip:
Avoid slippage:

- Fix at one fixing point
- Then drill further holes, etc.

6 Optional: Connect two rolls with a middle bar (underneath a divider)

A Insert the middle bar **KEW Plus LL-M**

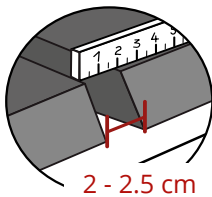

2 - 2.5 cm

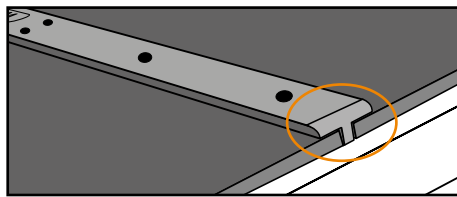

- Rounded off end on the rear edge
- Flush with the rear edge of the mat



DO NOT PRESS!

B Fix bars: See **5 B**